

Dual Air Fusion™

OPERATOR'S MANUAL



Safety Instructions

When using your heat press, basic precautions should always be followed, including the following:

1. Read all instructions.
2. Use heat press only for its intended use.
3. To reduce the risk of electric shock, do not immerse the heat press in water or other liquids.
4. Never pull cord to disconnect from outlet, instead grasp plug and pull to disconnect.
5. Do not allow cord to touch hot surfaces, allow heat press to cool completely before storing.
6. Do not operate heat press with a damaged cord or if the equipment has been dropped or damaged. To reduce the risk of electric shock, do not disassemble or attempt to repair the heat press. Take it to a qualified service person for examination and repair. Incorrect assembly or repair could increase the risk of fire, electric shock, or injury to persons when the equipment is used.
7. This appliance is not intended for use by persons (including children) with reduced physical, sensory or mental capabilities, or lack of experience and knowledge, unless they have been given supervision or instruction concerning use of the appliance by a person responsible for their safety.
8. Close supervision is necessary for any heat press being used by or near children. Do not leave equipment unattended while connected.
9. Burns can occur when touching hot metal parts.
10. To reduce the likelihood of circuit overload, do not operate other high voltage equipment on the same circuit.
11. If an extension cord is necessary, then a 20 amperage rated cord should be used. Cords rated for less amperage may overheat. Care should be taken to arrange the cord so that it cannot be pulled or tripped over.
12. **Important**

The Hotronix® Dual Air Fusion™ is equipped with a Quick Release Button located on the top of the control housing. When pressed, this button activates a quick release of the heat platen when in the print position and automatically returns the platen to the “UP” position. Once activated, the button can be reset by pushing it in. The press will then return to the Normal Operating Mode.

Light on = Normal Operating Mode

Light off = Quick Release Mode

13. In the event of a loss in air pressure to your machine while the heat platen is in the down or print mode, remove the opposite lower platen and push the top of the Dual Air Fusion over to the open position. (Fig. 1)



Fig.1

Product Warranty Registration

Log onto Hotronix.com/registration. You must provide the Hotronix® heat press serial number and model information.

Safety Instructions	2
Machine View	4
Touch Screen Guide	5
Operating Instructions	6-18
Connecting the System	6
Start Up/Shut Down	7
Print Screen	8-10
Passwords	10
Setup Menu	11-17
Preset Setup	11-12
Date & Time Setup	13
Display Setup	13
Auto On and Off Setup	14
Passwords Setup	15
Language Setup	16
Laser Setup	16
System Setup	17
Prepare to Print	18
Replacing Parts	19-21
Electrical Schematic	22
Contact	23



HOTRONIX® DUAL AIR FUSION™

Machine View

1. Print Buttons
2. Casters
3. Alignment Lasers (Optional)
4. Bellow
5. Circuit Breakers & IEC Inlet
6. Air Connect
7. Air Hose
8. Foot Pedal
9. Power Cord



10. ON/OFF Switch
11. Quick Release Button
12. Touch Screen
13. Upper Platen
14. Lower Platen A
15. Lower Platen B
16. Base
17. Platen Release Lever



■ Navigation

Most screens have a Cancel or Back button to close the current screen without saving any changes and will return the user to the previous screen. (Fig.1)

Some screens may present a list of items. When the list of items is larger than can be displayed on a single screen, a left and/or right arrow appears on the left or right side of the screen. A user can scroll through the list by making a sweeping gesture across the screen, either left and/or right, as indicated by the arrows. The user must be touching the screen for the gesture to be detected. Very fast and very slow gestures may not be recognized. (Fig.1)



Fig.1

■ Editing

Editable fields may be displayed in an Edit Box. An Edit Box typically overlays the screen and presents field(s) and/or control(s). Edit Boxes typically do not have a Back or Cancel button. The Edit Box can be closed by touching the screen anywhere outside the Edit Box. A Save or Enter button may be displayed in an Edit Box. Closing the Edit Box without pressing the Save button will result in the loss of your changes. (Fig.2)



Fig.2

In addition to editable fields, an Up/Down icon may be provided to increase or decrease values. The Up/Down icon (in most cases) can be held down to automatically increase or decrease the value. (Fig.3)



Fig.3

■ Keypad Display

The Keypad display is used for data entry purposes. This is used to enter text or numeric data when required. The Keypad provides function keys for Cancel, Enter and Backspace/Clear (“<”) keys. Also, a mode key may be present between the Cancel and Enter key. The mode key allows the user to switch between upper and lower case letters and numeric and other characters that may be entered using the Keypad. (Fig.4)

Typically, the current value is displayed in the Keypad value display at the top of the screen. Use the Keypad to change the current value. Use the Enter key to accept the change or the Cancel key to exit without accepting the change to the current value. (Fig.4)



Fig.4

The Keypad display is also used for password entry. Password characters will be displayed with “*” in place of the password value.

■ Menu Selection

The available Menu Screens are displayed as icon images on the screen. Touch and release the icon to open the desired Menu Screen. (Fig.5)



Fig.5

HOTRONIX® DUAL AIR FUSION™ Operating Instructions

The Hotronix® Dual Air Fusion™ Operating Instructions are designed with the user in mind. Carefully read and follow the step-by-step instructions for best results.

- To avoid burns, do not touch the heated platen during use.
- Keep hands clear of the upper platen of the press during platen lock down as the pressure may cause injury.
- Work area must be kept clean, tidy and free of obstructions.
- Power supply cord must be disconnected before cleaning or servicing press.

Connecting the System

1. Connect the power cord into the IEC inlet located on the side of the Press. Connect the opposite end of the cord into a properly grounded electrical outlet with a sufficient amperage rating. (1.1)

- **Voltage**

220 Volt - A full 10 amp grounded circuit is required for 220 volt operation.

- **Extension Cords**

If used, extension cords should be as short as possible and not less than 12 gauge. Heavy duty cords are recommended.

- **Circuits**

Circuits that have less than 15 amps or that have other high demand equipment or appliances (especially more than one heat press) plugged in, should not be used.

Note: If the supply cord is damaged, it must be replaced by the manufacturer, its service agent or a similarly qualified person in order to avoid hazard. Use SJT type rated 300 V cord for replacement.

- **Connecting the Air Compressor**

Connect the Air Hose (provided) from your air compressor into the Air Connector located on the back of the press. (Fig. 1.2)

Note: Air compressor must be 1 hp compressor or larger, 2.3 cfm, with a 5 gal. tank minimum. If the compressor is not connected properly or the pressure is turned off, the Dual Air Fusion will warn you with this icon. (Fig. 1.3)

Press the icon when air pressure is restored.



1.1



1.2



1.3

CAUTION Failure to follow these instructions will cause:

1. Erratic controller functions.

2. Inaccurate displays and slow heat-up.

3. The circuit breaker to disengage.

Start Up/ Shut Down

- 2.** To start your Dual Air Fusion™ Heat Press, flip the power switch to the “On” position.



2.1

The power switch is located on the top of the control housing. (2.1)

During the startup, a splash screen is shown for approximately 3 seconds. This screen displays the Hotronix® logo and current software version. (2.2)



2.2

To turn your Dual Air Fusion Press off, select the “Shut Down” button on the print screen. (2.3)

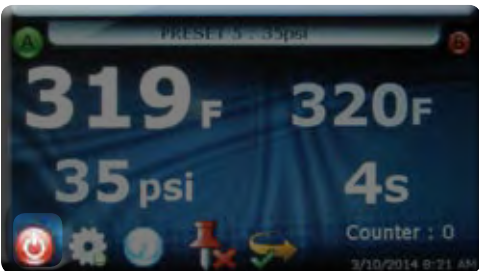

2.3

Note: When the heat platen is above 100°F (38°C), the current platen temperature is displayed on an orange background as a warning, indicating that the platen is still hot. (2.4)



2.4

During this time, the Shutdown operation can be exited by simply pressing the green start button displayed on the touch screen (2.4). The system will exit the Shutdown screen and return to the print screen.

Once the platen has cooled below 100° F (38° C), a screen saver will display, showing the Stahls Hotronix® logo, START, and Shut Down buttons. (2.5)



2.5

Press and Hold the red Shut Down button until this screen appears. (2.6)

Flip the main Power Switch at the top of the press to the off position.



2.6

Note: The Dual Air Fusion is equipped with an Auto Sleep Mode. When the machine is not in use for a period of four hours, it will enter an energy saving sleep mode. To restore to normal operating mode, press the start button located on the touch screen and allow the heat press to return to the target temperature.

Operating Instructions

Print Screen

3. The Print Screen is the first screen displayed after the splash screen and start up has completed. This screen provides all the printing functions.

■ Presets

Saved Presets are displayed at the top of the Print Screen. These are pre-programmed heat application settings that allow you to quickly and accurately change your print settings for specific materials. The example shown is a preset named “PRESET 5” with a first timer of 4 seconds, a target temperature of 320°F, and a platen pressure of 35psi. (3.1)

To select a new application setting, press the preset bar at the top of the Print Screen. (3.1)

A pop up menu with all of the optional presets will be displayed. Press your desired preset. (3.2)

Note: if there are no Presets pre-programmed on your system, the Preset menu will be blank. To edit, delete or create new presets, see ‘Preset Setup’ on pages 11 and 12.

Press the blue arrow icon to toggle between the A and B platens to assign your selected preset to your desired platen. Select the “ACCEPT” icon when finished. (3.3)

The system will automatically return you to the Print Screen showing your new preset settings.

■ Target Settings

Your target Temperature, Time and Pressure settings are displayed as shown. (3.4). These settings may be overridden.

Note: when changing a Target Setting, the Preset display name at the top of the screen will change to “Override” to indicate the Preset has been manually changed.

To change your Temperature Settings, press the Target Temperature display located on the right side of the print screen. A pop up menu will be displayed. Press the blue or red temperature icons to decrease or increase the temperature (press and hold to change values faster). (3.5)

Note: The temperature can be set from a range of 32°F (0°C) to 430° F (221°C).

To change your Time Settings, press the Target Timer display located on the right side of your print screen. A pop up menu will be displayed. Press the minus or plus icons to decrease or increase the time (Press and hold to change values faster). (3.6)

Note: The time can be set from a range of 1-999 seconds



3.1



3.2



3.3

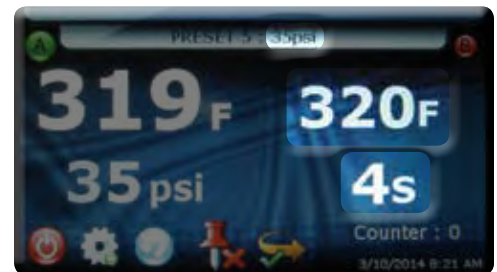

3.4

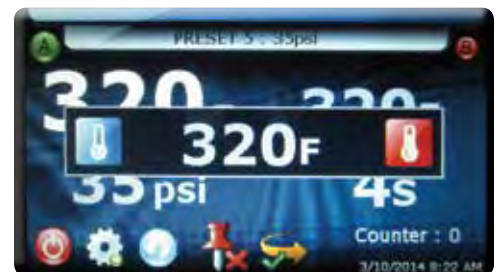

3.5

Print Screen Cont.

■ Target Settings Cont.

To change your Pressure Settings, press the Target Pressure display and a pop up menu will be displayed. Press the down or up arrows to decrease or increase the pressure (Press and hold to change values faster). (3.7)

Note: The pressure can be set from a range of 20psi (1.4bar) to 120psi (8.3bar).

■ Actual Readings

The Actual Temperature and Pressure readings are displayed on the left side of the Print screen. These are the current heat press readings. (3.8)

■ Job Counter

The Job Counter counts the total number of complete print cycles performed using the current Preset or Override settings. Exiting the Print Screen or changing the Preset will reset the Job Counter to 0. Changing an Override setting does not reset the Job Counter to 0. (3.8)

■ Station Indicator

A and B icons indicate which platen or station your current heat application settings will be applied to. A larger green icon indicates an active platen and a smaller red icon indicates an inactive platen.(3.9)

Power Button

Use the Power Button to perform system shutdowns. (3.9)

Note: See “Start up / Shut Down” on page 7.

Setup

The Setup menu allows you to edit and create Presets, program the Date and Time, change your display units (F°/C° and psi/bar), set your Auto On/Off functions and more. A password is required to enter the Setup menu. The system supports two levels of passwords: “User” and “Manager”. Features of the Setup menu are limited by the password level entered. (3.9)

Note: See “Passwords” on page 10.

Refresh Button

When using a Preset with multiple timer settings programmed, press and hold the refresh button to revert back to the first timer setting when desired. (3.10)

Tack Mode

When Tack Mode is enabled, the platen is lowered as long as both print buttons are pressed and held. Touch the tack button to toggle the Tack mode. A green check mark indicates the Tack Mode is enabled. A red X indicates that Tack Mode is disabled. (3.10)

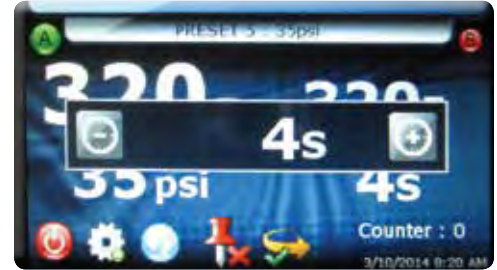

3.6



3.7



3.8



3.9





3.10

Print Screen Cont.

Auto Shuttle Mode

With Auto Shuttle Mode enabled, your Dual Air Fusion™ will automatically transition from one platen (A & B) to another after each heat application.

Press the auto shuttle button to toggle the Auto Shuttle Mode.

-  A green check mark indicates the Auto Shuttle Mode is enabled.
-  A red X indicates Auto Shuttle is disabled.
-  A white "footprint" indicates the foot switch is enabled. (3.11)

Note: See "Prepare To Print" on page 18 for further details.

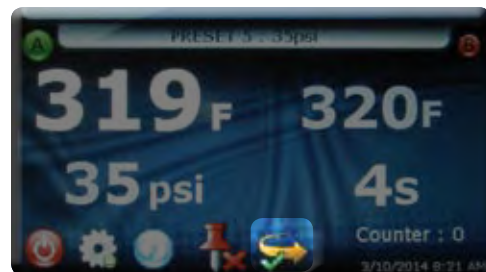

3.11

Passwords

4. A password is required to access the Setup Menu and configure certain functions of the Dual Air Fusion. The system supports two levels of passwords: "User" and "Manager". The User Level password provides access only to the Preset Setup, Date & Time, Display, and Auto On/Off Setup screens. The Manager Level password provides access to the Preset Setup, Date & Time, Display, Auto On/Off, Password, Language and System Setup screens.

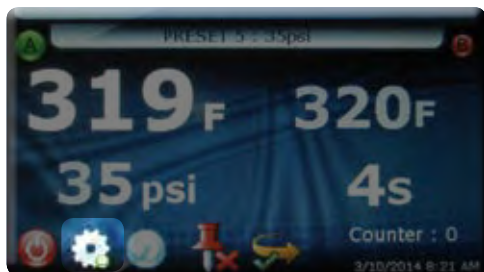

4.1

In the Print Screen, press the Setup icon. (4.1)

Then press the Setup icon again. (4.2)

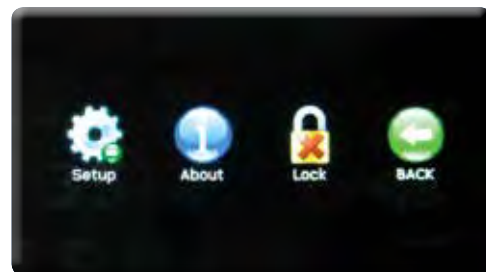

4.2

A keypad will be displayed. Enter the letter "U" for a user level password or "M" for a manager level password (4.3)

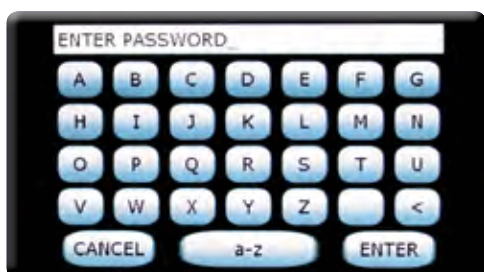

4.3

Note: we will continue under a "User Level" password.

Press Enter when complete.

If an invalid password is entered, simply repeat the previous step. (4.4)

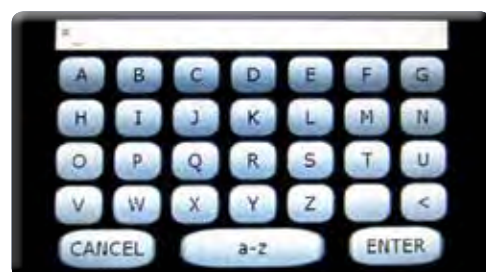

4.4

Note: You can Select the Cancel button to exit the Password Entry screen and return to the previous screen at any time. Now you will be automatically entered into the Setup Menu where you will have access to the Setup functions. (5.1)

Preset Setup

5. After your password is entered in the setup menu, press the Preset Setup icon. (5.1). This option will allow you to edit, delete, and create new Presets. A preset can have:

- 1 Preset Name
- 1-4 Timer values each with a range of 1-999 seconds
- 1-4 Platen Pressure settings each with a range of 20 -120psi (1.4 - 8.3bar)
- 1 Temperature value with a range of 32 - 430°F (0°- 221°C)



5.1

■ **To create a new Preset:**



5.2

Press the NEW button on the preset setup screen (5.2).

First, give the Preset a name by selecting the Preset Name field. (5.3)

A keypad will be displayed. (5.4)



5.3



5.4

Type in the name of your new Preset and Press ENTER when finished. (5.4)

Repeat the same process for your new Preset Timer, Pressure, and Temperature fields.



5.5

If desired, you can also change the Pressure and Temperature units here by pressing the F or C (Fahrenheit/Celsius) and psi or bar icons on the right side of your screen. (5.5)

Press the SAVE button when finished. (5.5)



5.6

Note: if you receive an error message after saving, select the Error message icon. (5.6)

A Preset Error menu will display, informing you of any changes needed. (5.7)



5.7

Note: A common error is when the amount of Timer fields entered (1-4) does not equal the amount of Pressure fields entered (1-4). For example, if you assign the Preset two Timer settings, it must have two Pressure settings. Press the yellow Error icon again to close the Error menu and make any necessary corrections. Press the SAVE button again when finished.

Preset Setup Cont.

■ **To Create a New Preset (Continued):**



5.8

Note: A DELETE button will appear after saving if you do not want to save. (5.8)

Press the BACK button until you return to the Print Screen. The message “Saving Settings! Please wait...” will appear.



5.9

Press the Presets bar at the top of the Print Screen to select your New Preset. (5.9)



5.10

Locate and select your New Preset. (5.10).

Press the blue arrow icon to assign your selected preset to your desired platen (A or B) then press ACCEPT. (5.11)

The Print Screen will now display your new settings.



5.11

■ **To edit an existing Preset:**

In the Preset Setup menu, press the name of the Preset you'd like to change. (5.12)

Note: If a blue arrow appears on your screen, this indicates there are more presets hidden from view. Slide your finger across the screen towards the arrow to view the rest of your Presets.

Select the desired field (Preset Name, Timer, Pressure or Temperature) that you wish to edit. A keypad will be displayed. Use the left arrow (<) to override the current name or value, then key in your new entry desired. Press ENTER when finished (or X to cancel).



5.12

■ **To Delete a Preset:** In the Preset Setup menu, Select the name of the Preset you wish to delete. (5.12)



5.13

Press the DELETE button. (5.13)

A pop up menu will appear. Press ACCEPT to continue or CANCEL to return to the Preset Setup page. (5.14)



5.14

Date & Time Setup

- 6.** The Date and Time Setup feature allows you to program the Month, Day, Year, Hour and Minute (displayed in the lower right corner of the Print Screen).



6.1

To set the Date and Time, press the Date & Time button in the Setup screen. (6.1)

Press the "Month" field. (6.2)

Change the numeric value using the displayed Keypad, then press Enter. (6.3)



6.2

Repeat the same process to set the Day, Year, Hour and Minute. Select the AM/PM field to toggle between the AM/PM settings.



6.3

Press the SAVE button followed by the BACK button to return to the Setup menu. (6.4)

Note: It may take a few seconds for the Date and Time display to update on your screen.



6.4

Display Setup

- 7.** The Display Setup allows you to change your Temperature (Fahrenheit/Celcius) and Pressure (psi/bar) units.



7.1

To change your display units, press the Display button in the Setup screen. (7.1)

Press the Temperature field (F or C) to toggle between Fahrenheit and Celcius. (7.2)



7.2

Press the Pressure field (psi or bar) to toggle between psi and bar. (7.2)

 Press the SAVE button to save your changes,

 followed by the BACK button to return to the Setup menu.

Auto On and Off Setup

- 8.** The system can turn On or Off automatically when configured. The Auto On and Off feature is configured for each day of the week.



8.1

In the Setup Menu, Select the Auto On/Off Button. (8.1)



8.2

To configure an Auto On/Off setting, select the day of the week to be configured. (8.2)

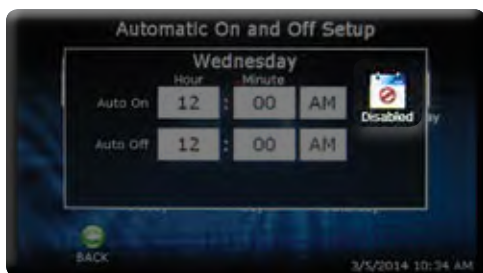

8.3

Use the Enable/Disable button to enable On/Off settings for the selected day of the week. (8.3)



8.4

Note: each day that you want the system to automatically turn On/Off, must be Enabled.

When enabled, set the time of day for Auto On and Off events by selecting the Hour and Minute fields. (8.4)



8.5

Using the displayed Keypad, enter the numeric time values and press ENTER. (8.5)



8.6

Use the AM/PM designator button to toggle between the AM or PM settings. (8.6)

Select the SAVE button to save the settings. (8.6)

Note: Selecting another day of the week or exiting the Auto On and Off Setup screen without saving will result in loss of changes.

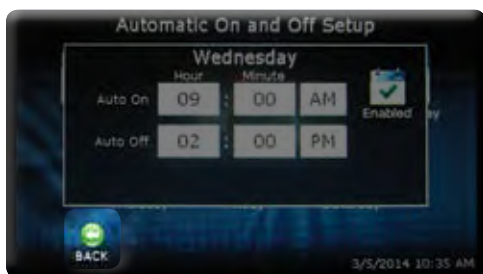

8.7

Press the BACK button to return to the Automatic On and Off Setup screen. (8.7)



8.8

Note: You will see a green check mark for any day you have your Auto On/Off Enabled. (8.8)

Passwords Setup (Manager Level Only)

- 9.** When logged in at a “Manager Level”, Passwords may be changed In the Setup menu. This will allow you to control who can access additional features in the Setup menu such as Passwords, Language, System, and Laser Setup.



9.1

Press the Passwords setup icon in the Setup menu. (9.1)

Select the Password level (User or Manager) to be edited. (9.2)

A Keypad will be displayed. (9.3)



9.2



9.3

Type in your new password and press ENTER when finished. (9.3)

Note: Do not forget your new Password(s). It will be required for future logins.

Save any changes prior to exiting the Password Setup screen to prevent losing your changes. (9.4)



9.4

You can also access the “Lock” function when logged in at a Manager Level. This feature will prevent a user from changing any print settings and functions of the print screen when heat applying.

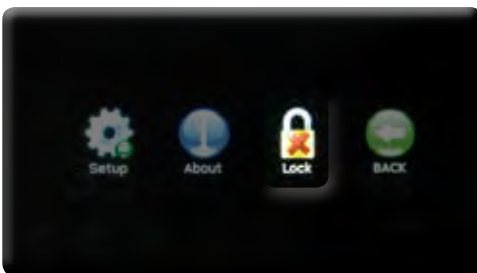

9.5

To Lock the print settings, Press the Lock icon in the Setup menu. (9.5)

Type in your Manager Level password and press ENTER when finished. (9.6)

Note: The “Unlock” icon will now be displayed in the setup screen if you wish to Unlock the print settings. (9.7)

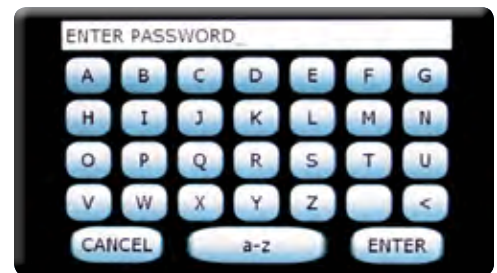

9.6



9.7

Press the BACK button in the Setup menu. (9.7)

The print screen will now display the Lock icon indicating the heat application settings will no longer be editable. (9.8)

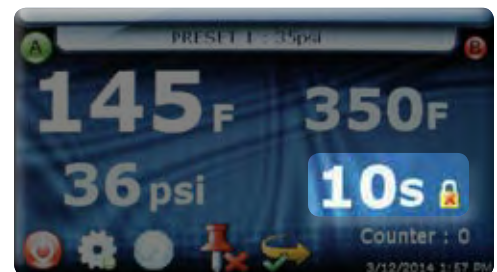

9.8

Language Setup (Manager Level Only)

- 10.** When logged in at a “Manager Level”, the display Language may be changed in the Setup menu. Choose from eight languages: English, Deutsch, Espanol, Francais, Italiano, Japanese, Pyccko, and Chinese.



10.1

In the Setup Menu, Select the Language Button. (10.1)

Press the icon of your Desired Language. (10.2)

Note: The selected icon will appear larger than unselected icons.

This example shows the Language “Espanol” being selected. (10.3)



10.2



10.3

Once the desired language is selected press the Save button. (10.3)

The Dual Air Fusion™ will automatically restart and return you to the Print Screen using the new Language display settings. (10.4)



10.4

Laser Setup - Optional (Manager Level Only)

- 11.** With the Laser Alignment System installed and when logged in at a “Manager Level”, the Laser Setup function will allow you to turn individual lasers on and off at both A and B platens.



11.1

In the Setup Menu, Select the Laser Setup Icon. (11.1)

In the Laser Setup Menu, press icons A0-A3 to toggle lasers on or off for Position A. (11.2)

Note: Green Icon = Laser On
Red Icon = Laser Off



11.2

Repeat these same steps for Position B.

Note: When assigning your laser setup, you can change your shuttle function from Auto, Manual, or Foot Switch mode (shown - 11.2). This is used to move your platen from position A to B to view your Laser Setup when adjusting.

Press the SAVE button to save your changes, followed by the BACK button to return to the Setup menu.

System Setup (Manager Level Only)

- 12.** When logged in at the “Manager Level”, system functions such as Power Save Status, Auto Shuttle, Foot Switch, and Key Touch Frequency can be turned on, off, or adjusted in the Setup menu.

Press the System icon in the Setup menu. (12.1)



12.1

■ **Internal Temperature**

The current internal temperature reading of the system is displayed.

■ **Power Save Status**

With the Power Save Status turned on, the system will automatically shut down after 4 hours of inactivity to save power. The Power Save Feature can be turned On or Off by selecting the On/Off button. (12.2)



12.2

■ **Auto Shuttle**

The Auto Shuttle feature can be turned on or off using this control. With the Auto Shuttle feature turned off, you will also have the option to turn the foot switch on or off. (12.3)



12.3

■ **Key Touch Frequency**

When the user touches a control on the screen an audible tone is produced as a verification that a control was touched. The tone frequency can be changed by adjusting the Key Touch Frequency system setting. (12.3)

Use the plus / minus (+/-) buttons to adjust the frequency setting or select the field value to display a Keypad for editing the value. (11.4)

Note: The value can be set in the range of 1 - 10000 Hz. (11.4)

After your new frequency value is entered, press the ENTER key. (12.4)

Press the SAVE button to save any changes, followed by the BACK button (12.5).

Press the BACK button again in the Setup menu to return to the Print Screen.



12.4

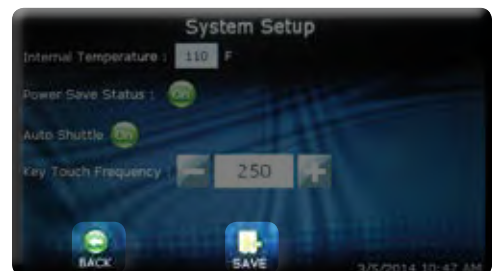

12.5

Prepare to Print

13. To begin Printing/Pressing, start by verifying that you have the proper settings selected in the Print Screen: (13.1)

- Do you have the correct preset selected?

Note: You may also manually adjust your desired Time, Temperature and Pressure settings (refer to Target Settings on pg 8-9).

- Has your Actual Temperature Setting reached the Target Temperature?
- Is your Actual Air Pressure the same as your Target Air Pressure.
- Do you have your Tack Mode and Auto Shuttle Mode set to your desired settings?



13.1

When the desired settings are reached you may begin to Print / Press.

- With the Auto Shuttle function enabled:

Position the heat platen from lower platen A or B by depressing the foot pedal. (13.2)

Position the garment and application.

Note: If your Dual Air Fusion is equipped with the Laser Alignment System, see Laser Setup on page 16 for positioning your application.



13.2

Press the Print buttons located on the side of the Dual Air Fusion™.

The platen will lower into the press position. The timer will automatically begin to count down, indicating the remaining time on the application.

CAUTION: With Auto Shuttle mode enabled; When the Print cycle is complete, the top platen will return to the up position and automatically Shuttle to the opposite platen.

If a second application is desired, repeat the previous step.

- If Printing with Auto Shuttle function disabled:
After positioning your garment and application, manually slide the heat platen over the garment until the desired platen icon on your Print Screen turns green.

Optional Pre-Press Tack Mode

With the Tack Mode enabled on your Print Screen, move the heat platen by depressing the foot pedal and position the garment and application. Press the foot pedal again to return the platen back over your garment and application.

When you are ready to print, press and hold the print buttons located on the side of the Dual Air Fusion. The top platen will lower into the Print position and will remain there until you release the buttons.

CAUTION: Once the Print Buttons are released, the top platen will return to the up position.

- To exit the Tack Mode, simply press the Tack Mode icon.

HOTRONIX® DUAL AIR FUSION™ Parts Replacement List

Item #	Part Name	Part #	Qty.
1	Control Housing	1-2197-1	1
2	Switch On/Off Lighted	1-2087	1
3	Quick Release Button	1-2270	1
4	Switch, Print, Canada	1-2319	2 each
5	Touch Screen Controller	1-2266	1
6	Control Housing Overlay	1-2198	1
7	Power Cord	2-1013-1	1
8	Print Valve	1-2298	1
9	Swing Valve	1-2299	1
10	Mini Regulator	1-2297	1
11	E/P Regulator	1-2293	1
12	Main Swing Spindle	2-1670	1
13	Flange Bushing 1"	1-2282	1
14	C-Clip	1-2286	1
15	Air Cylinder	1-2264	1
16	Spanner Nut	2-1006-95	1
17	Upper Casting	3-1341	1
18	Press Mount	1-2347	1
19	Silicone Pad 16x20, Blue	1-2136	2 each
20	Lower Platen, 16 x20	2-1029-HD	2 each
21	Quick Release Pin	1-2215	2
22	Adapter Plate	3-1336	2
23	Guide Tube	1-2290	1
24	Heat Platen Cover	1-2263	1
25	Heat Platen 16x20	2-1002-3-HW	1
26	Thermostat	1-2076	1 each
27	Silicone Dampener	No part #	1
28	Rodless Cylinder	1-2338	1
29	Right Side Tin (Part of Tin Assembly)	1-2340	1
30	Circuit Breaker, 10 amp	1-1331-2	2
31	IEC Inlet	1-1759	1
32	Foot Pedal Assembly	1-2305	2
33	Access Plate (Part of Tin Assembly)	1-2340	1
34	Self Leveling Stem Caster/ (Part of Leg Assembly)	1-2345	4 each
35	End Cap (Part of Leg Assembly)	1-2345	2
36	Leg Assembly	1-2345	1
37	Rubber Foot (Part of Leg Assembly)	1-2345	4
38	Base Casting	4-1176	1
39	Air Filter	1-1215	1
40	Clamp Assembly	1-2332-1	2
41	Base Plate	No part #	1
42	Magnet, Slotted	1-1219	1
43	Drive Angle	1-2341	2 each
44	Hard Stop	1-2343	2 each
45	Carriage Plate	1-2344	1
46	Blocks (Part of Rails # 47)	1-2336	2 each
47	Rails	1-2336	2 each
48	Front Tin (Part of Tin Assembly)	1-2340	1
49	Keeper	1-2342	2 each
50	Probe	1-1272-1	1
51	Back Tin (Part of Tin Assembly)	1-2340	1
52	Cable Carrier	1-2337	1
53	Left Side Tin (Part of Tin Assembly)	1-2340	1
54	End Plate Stop	No part #	2 each
55	Bellow	1-2335	1
56	Laser Mount Bracket (Part of Laser Light Assembly)	No part #	1
57	Diode (Part of Laser Light Assembly)	No part #	4 each
58	Laser Holder (Part of Laser Light Assembly)	No part #	4 each
59	Laser Swivel Ball Plate (Part of Laser Light Assembly)	No part #	4 each
60	Laser Swivel Ball (Part of Laser Light Assembly)	No part #	4 each

HOTRONIX® DUAL AIR FUSION™

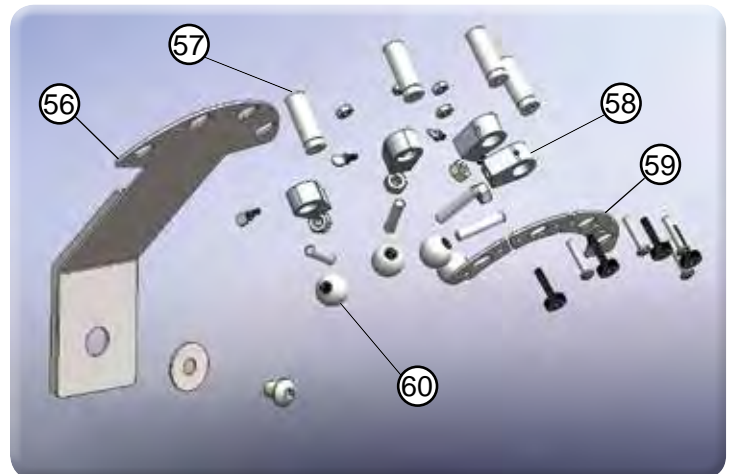
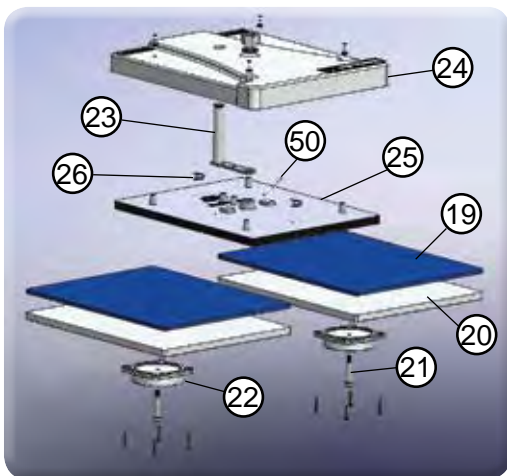
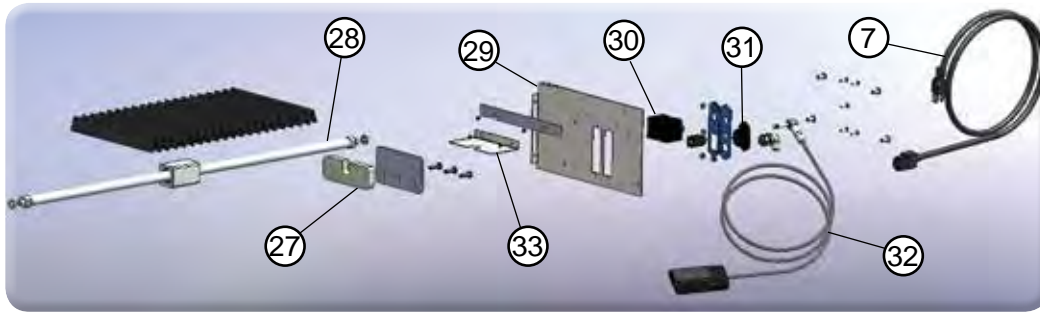
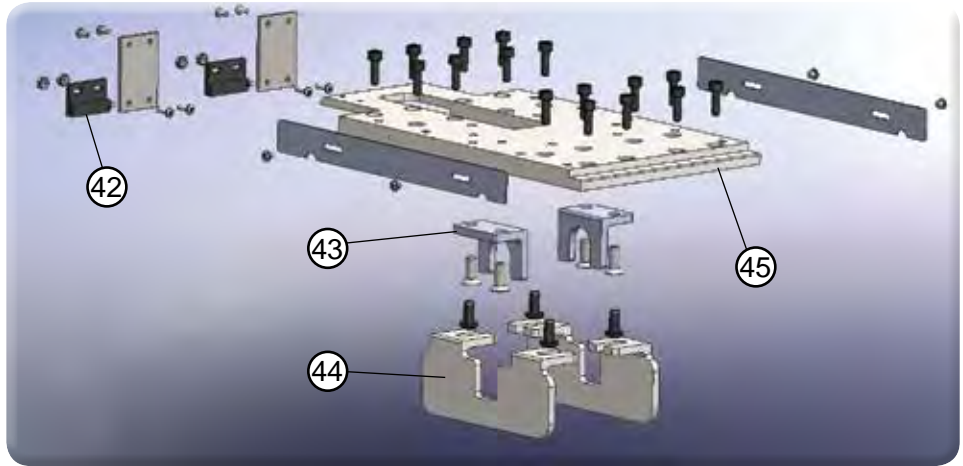
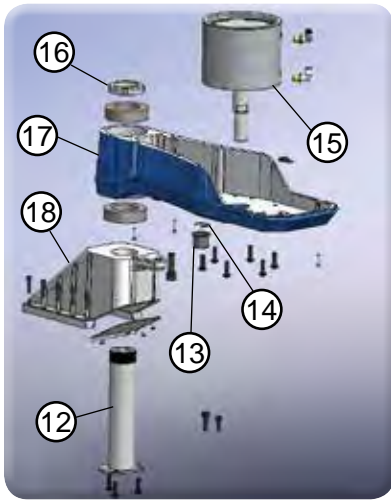

HOTRONIX® DUAL AIR FUSION™

Electrical Schematic

220V Version

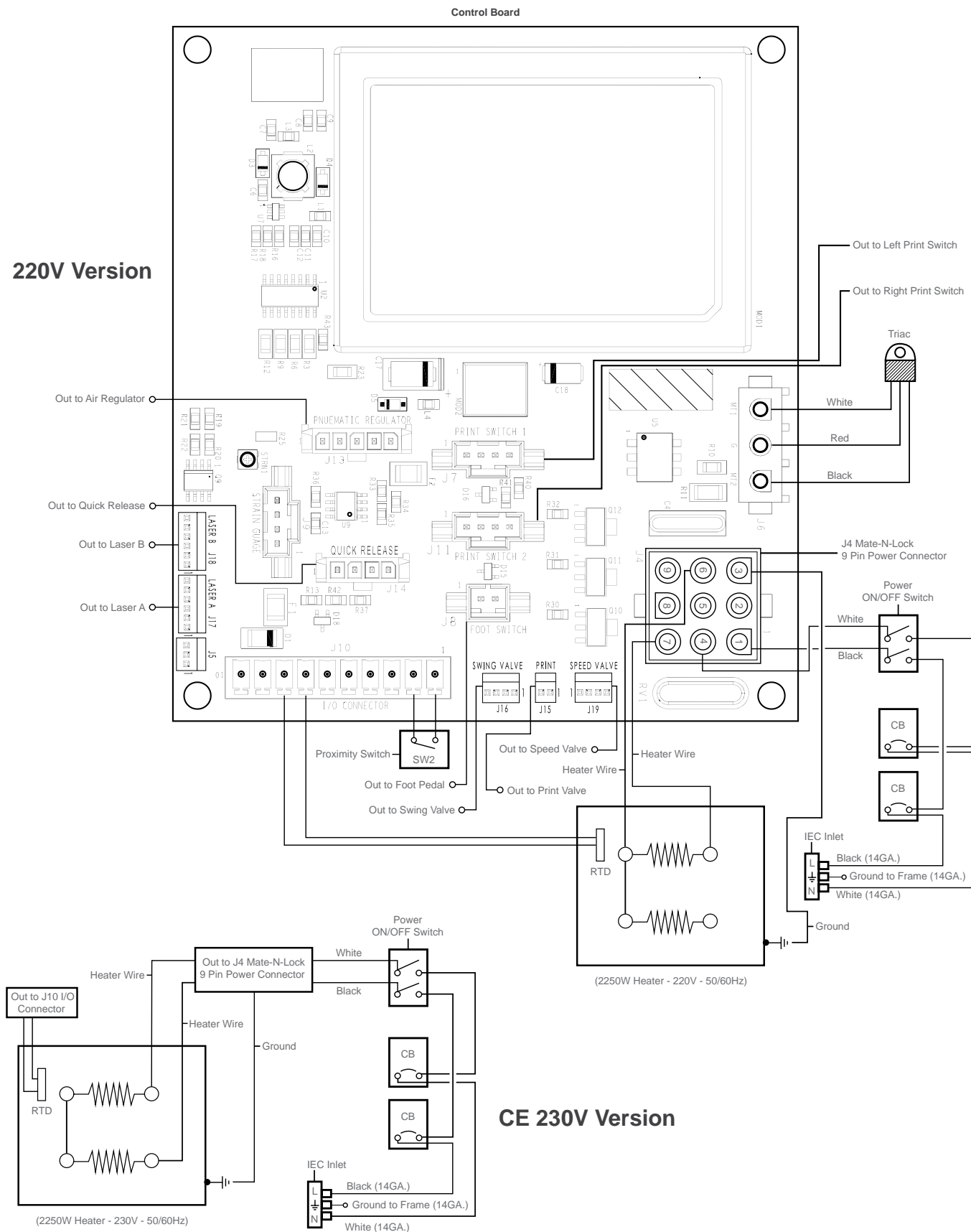

CE 230V Version

Contact us

Stahls' Hotronix®
One Industrial Park
Carmichaels, PA 15320
U.S.A.

Technical Support
800 . 727 . 8520
Monday - Friday
8am - 7pm EST

Customer Service
800 . 727 . 8520
Monday - Friday
8am - 5pm EST

Replacement Parts
800 . 727 . 8520
8am - 7pm EST

Web
Hotronix.com



This document includes multiple trademarks and describes equipment covered by many patents that are owned by GroupeSTAHL and/or its subsidiaries. GroupeSTAHL enforces its rights to protect these intellectual properties. © 2014

®

HOTRONIX

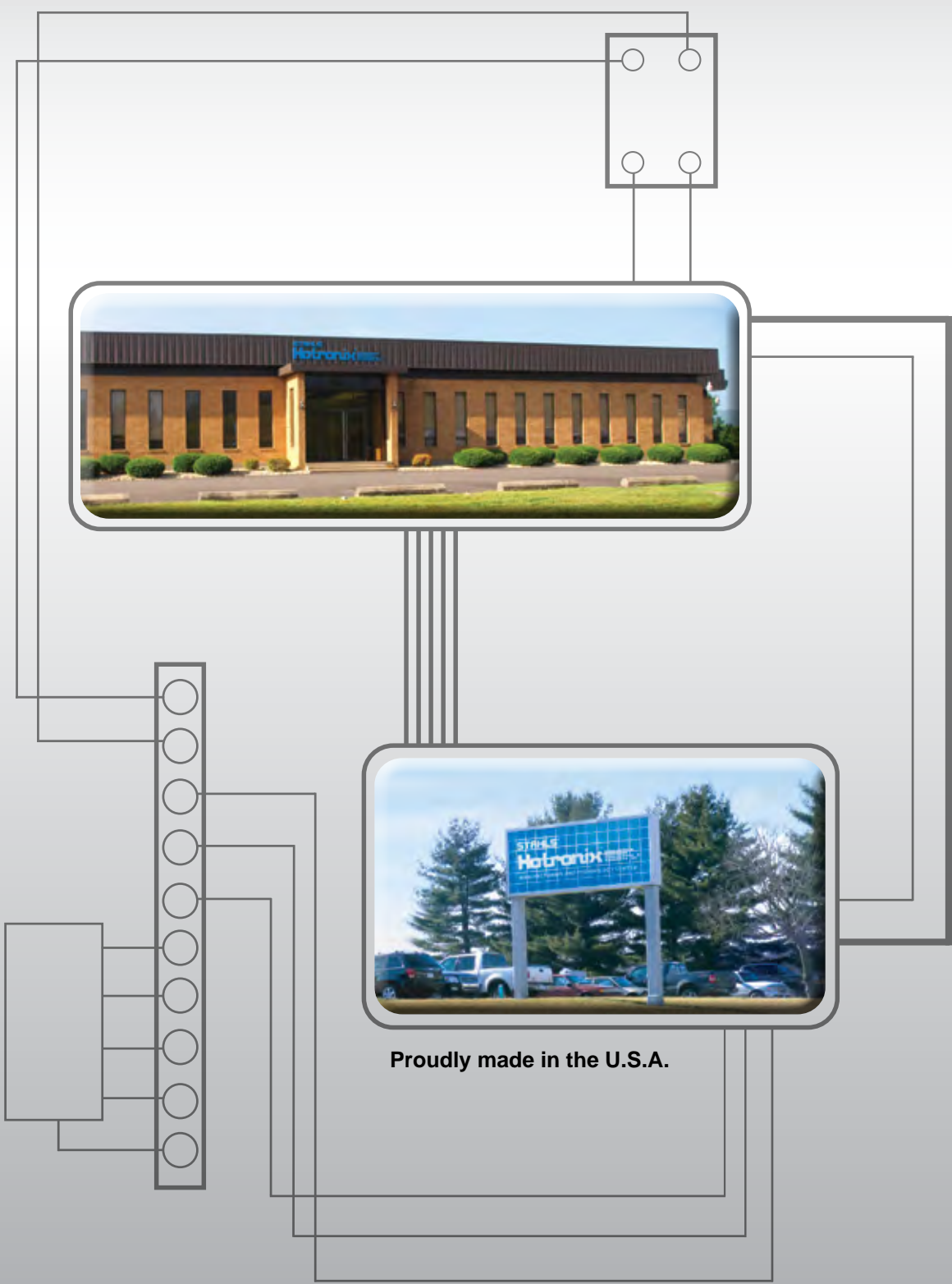

Proudly made in the U.S.A.

One Industrial Park . Carmichaels, PA 15320, U.S.A.
Tech Support - Customer Service - Replacement Parts: 800 . 727 . 8520
Web: Hotronix.com

STAHL'S
Hotronix®
a GroupeSTAHL company